

Slika 22.

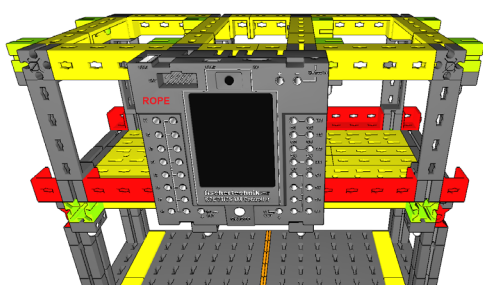

Slika 11.

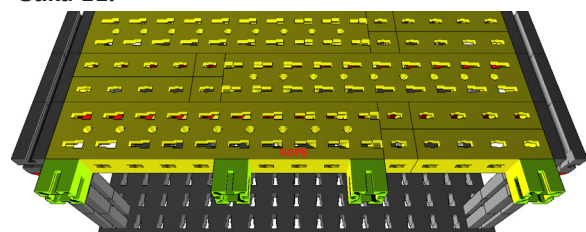

Slika 12.

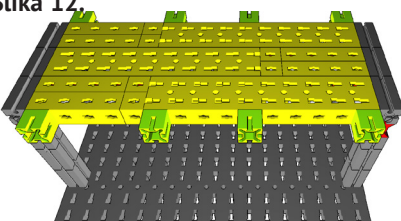

Slika 13.

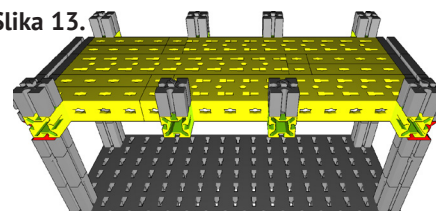

Slika 14.

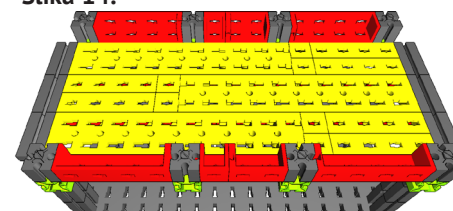

Slika 28.

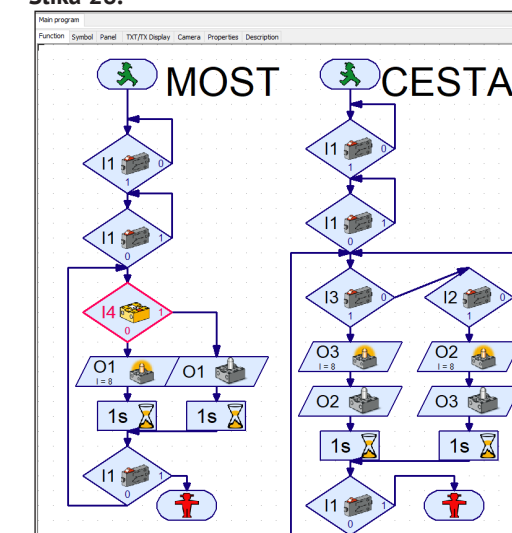

Slika 23.

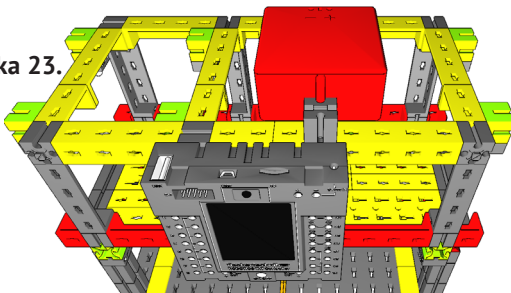

Slika 15.

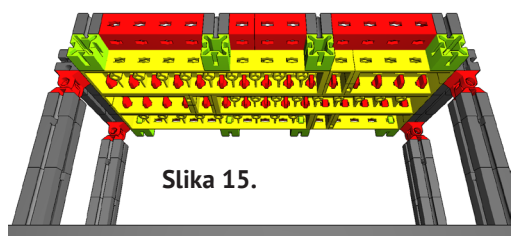

Slika 16.

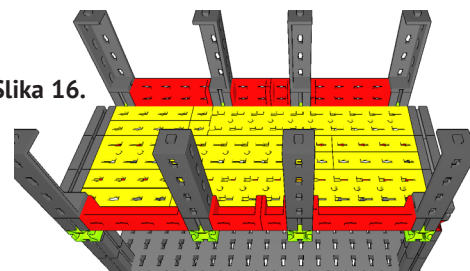

Slika 17.

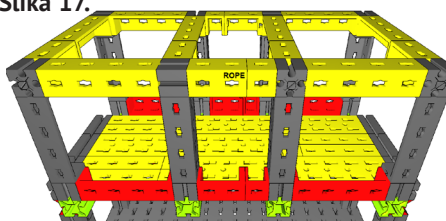

Slika 18.

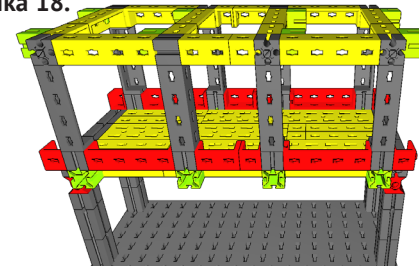

Slika 3.



Slika 19.

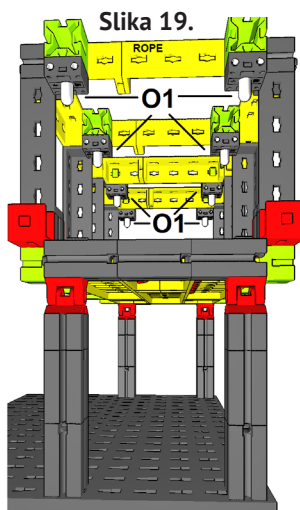

Slika 1.

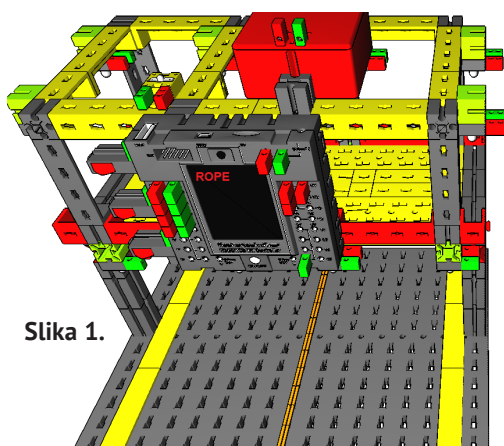

Slika 20.

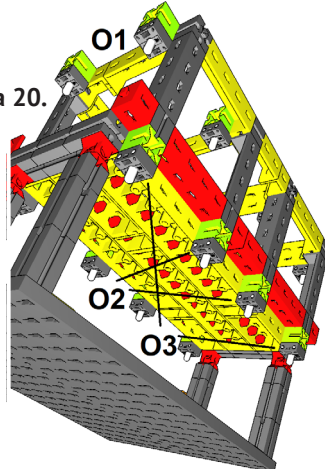

Slika 21.

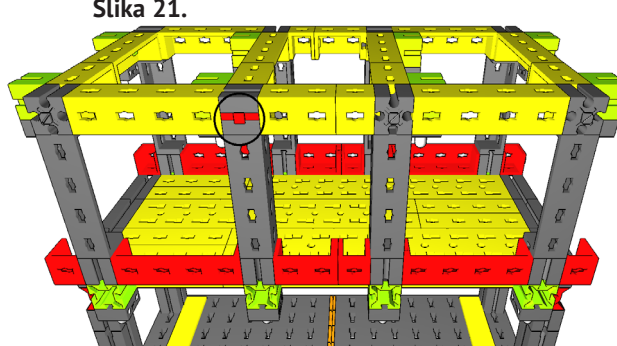

Slika 24.

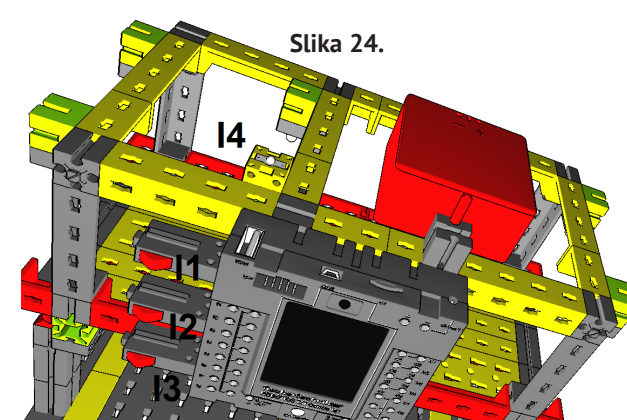

Slika 4.

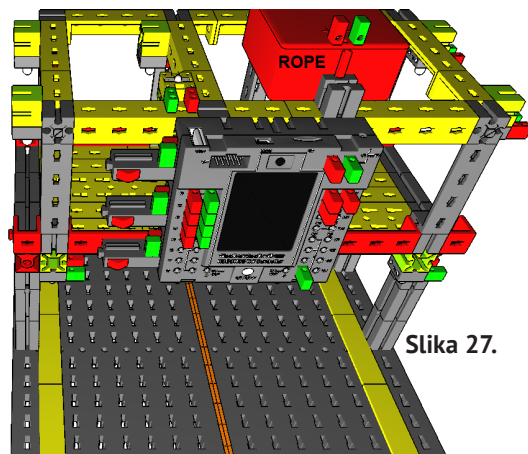
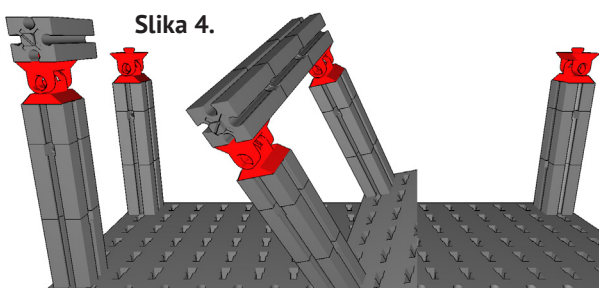

Slika 27.

Slika 8.

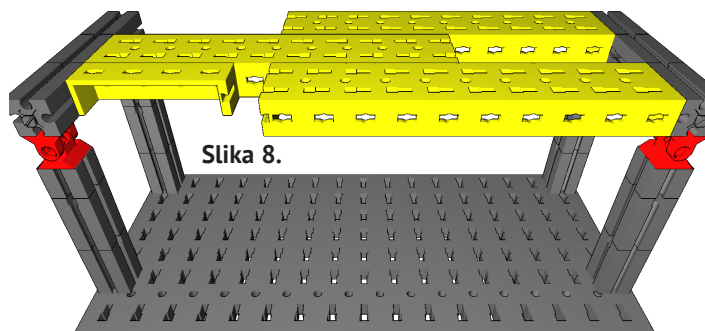

Slika 7.

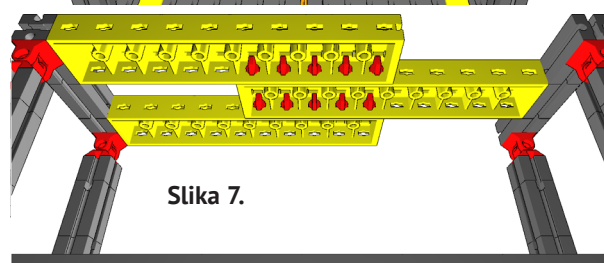

Slika 6.

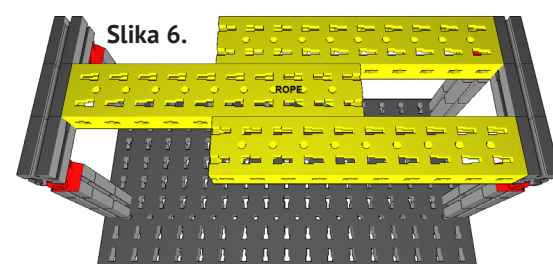

Slika 25.

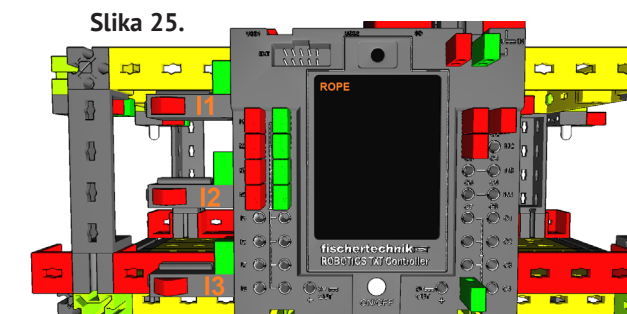

Slika 5.

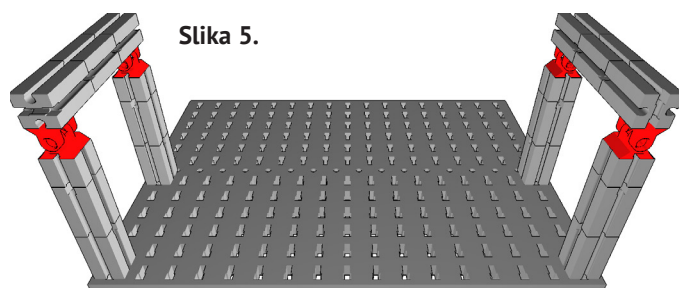

ABC
tehnike

Slika 9.

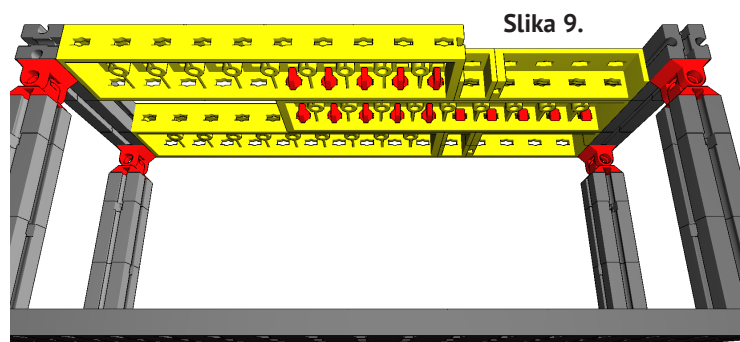

Slika 2.

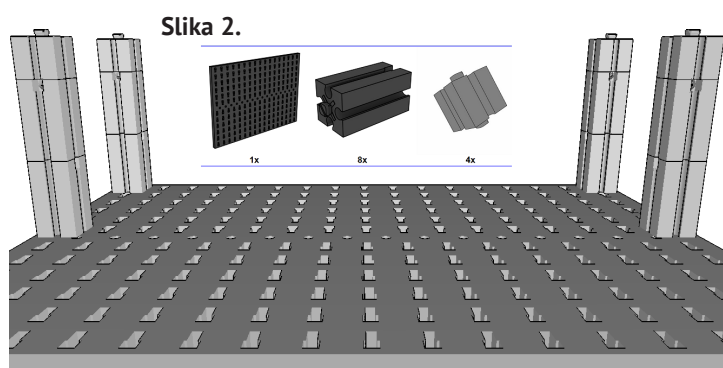

Slika 10.

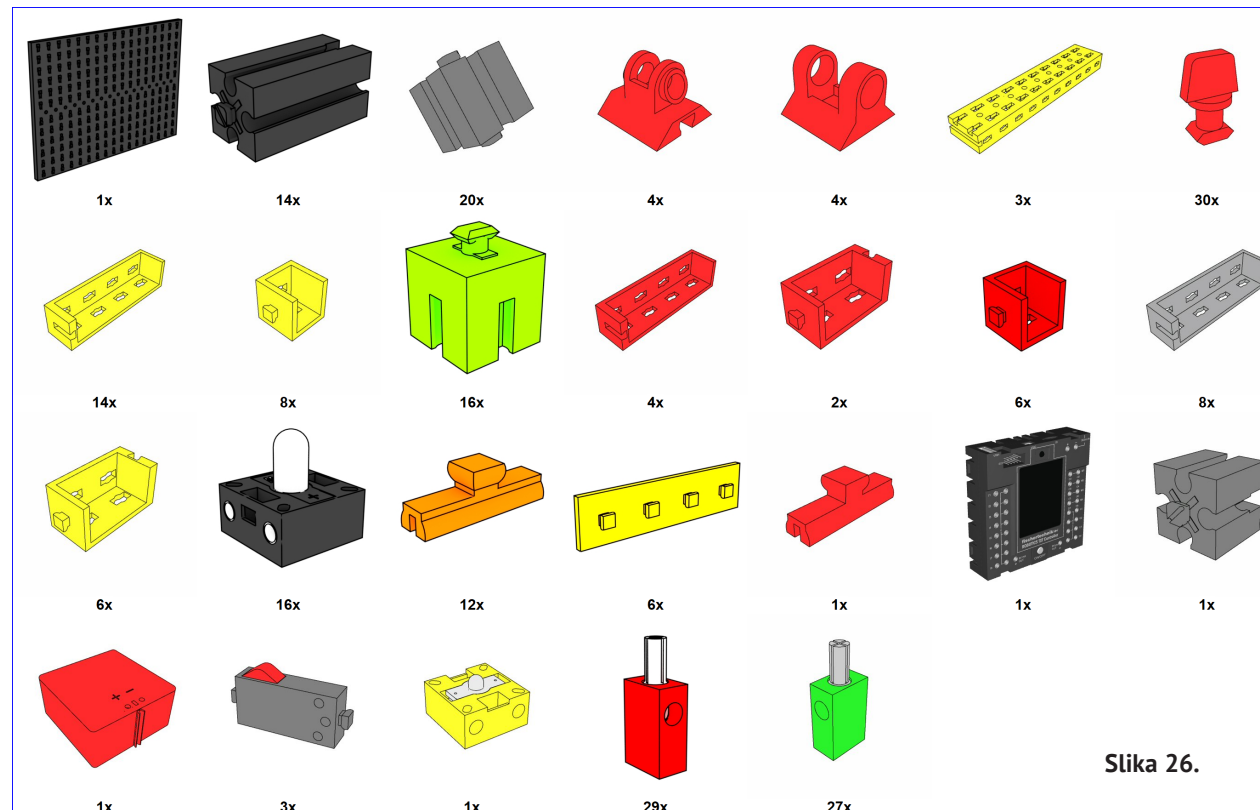
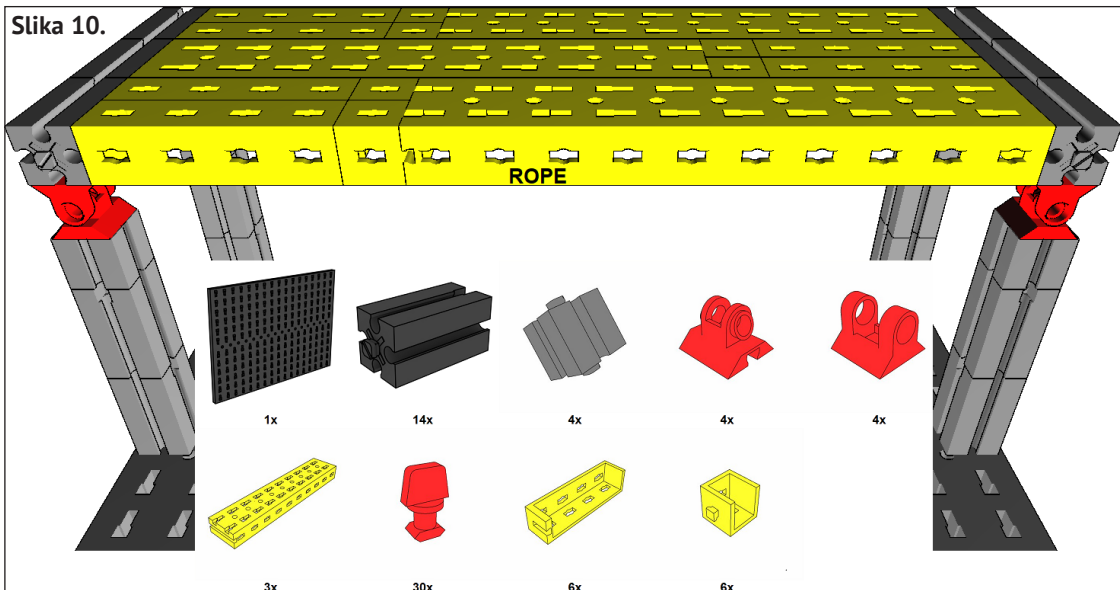

Slika 26.

Model pješačkog prijelaza [2]

KUTIJA ZA ELEKTRONIČKE SKLOPOVE



SKLOPNI CRTEŽ

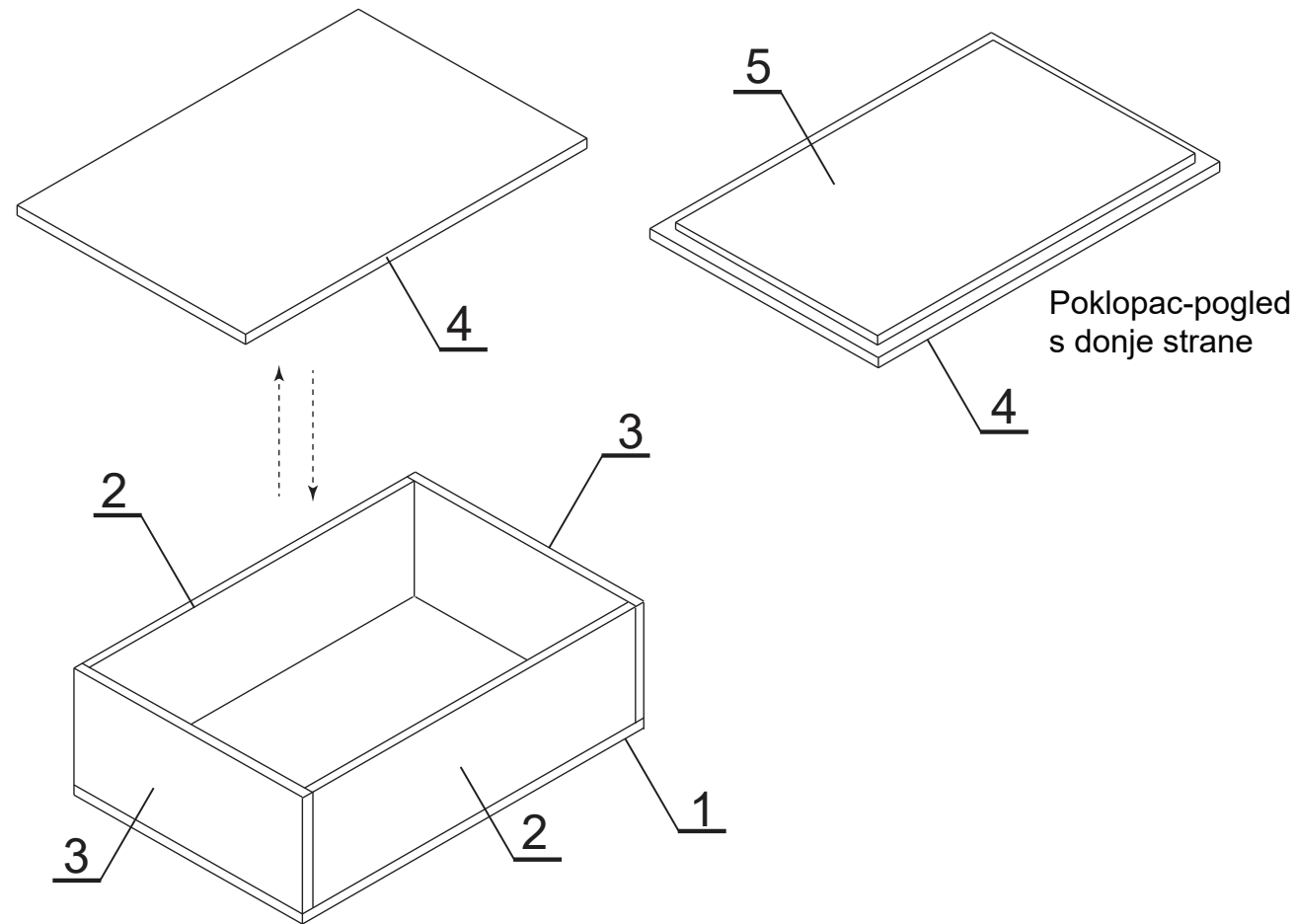

5	Poklopac-donji dio	1	šperploča	88x52x3 mm
4	Poklopac-gornji dio	1	šperploča	96x60x3 mm
3	Bočna strana-kraća	2	šperploča	60x30x3 mm
2	Bočna strana-duža	2	šperploča	90x30x3 mm
1	Donjište kutije	1	šperploča	96x60x3 mm
Poz.	Naziv	Kom.	Materijal	Napomena
Crtao:				Sklopni crtež
Mjerilo M 1:2	Naziv: KUTIJICA ZA ELEKTRONIČKE SKLOPOVE			1

PROMETNI ZNAK



SKLOPNI CRTEŽ

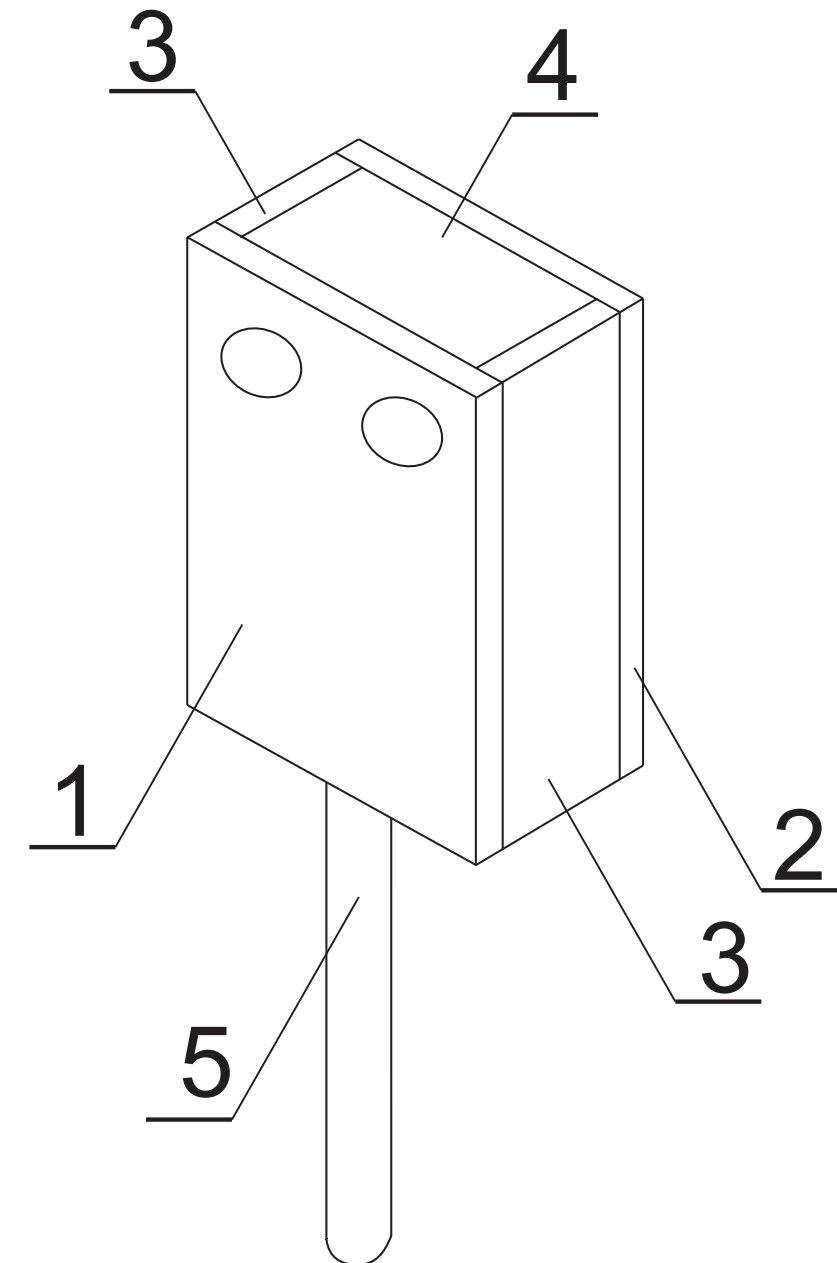

5	Stup	1	drveni štapić	∅5x50 mm
4	Gornji dio	1	drvena letvica	8x18x3 mm
3	Bočna strana	2	drvena letvica	8x30x3 mm
2	Stražnja strana	1	šperploča	24x30x3 mm
1	Prednja strana	1	šperploča	24x30x3 mm
Poz.	Naziv	Kom.	Materijal	Napomena
Crtao:				Sklopni crtež
Mjerilo M 2:1	Naziv: PROMETNI ZNAK			1